



Wide Input Voltage Range 30 Watt Dc-Dc Converter



FEATURES:

- 30W DIL PACKAGE
- Recognized By UL 60950-1
- 4:1 WIDE INPUT RANGE
- 100% BURNED IN
- HIGH EFFICIENCY
- UL 94V-0 PACKAGE MATERIAL
- CUSTOM SOLUTIONS AVAILABLE
- RoHS COMPLIANT
- 3 YEARS WARRANTY



Specifications typical at TA=25°C, nominal input voltage and rated output current unless otherwise specified

Part Number	Input Voltage	Input Current		Output Voltage	Output Current	Efficiency
	Vdc	No-Load (mA TYP)	Full Load (mA TYP)	Vdc	Full Load (mA)	%TYP
96DW-24S03RNL	9-36	25	1103	3.3	6500	81
96DW-24S05RNL	9-36	25	1524	5	6000	82
96DW-24S12RNL	9-36	25	1524	12	2500	82
96DW-24S15RNL	9-36	25	1524	15	2000	82
96DW-48S03RNL	18-72	20	545	3.3	6500	82
96DW-48S05RNL	18-72	20	753	5	6000	83
96DW-48S12RNL	18-72	20	753	12	2500	83
96DW-48S15RNL	18-72	20	753	15	2000	83
96DW-24D05RNL	9-36	25	1524	±5	±3000	82
96DW-24D12RNL	9-36	25	1524	±12	±1250	82
96DW-24D15RNL	9-36	25	1524	±15	±1000	82
96DW-48D05RNL	18-72	20	753	±5	±3000	83
96DW-48D12RNL	18-72	20	753	±12	±1250	83
96DW-48D15RNL	18-72	20	753	±15	±1000	83

Input Specifications

Parameters	Conditions	Min	Typ	Max	Units
Voltage Types				4:1	
Filter	Pi Network				
Protection	Fuse Recommended				

Output Specifications (Temperature Coefficient : ±0.05%/°C)

Parameters	Conditions	Min	Typ	Max	Units
Voltage Tolerance	Single/Dual			±2	%
Short Circuit/ Restart	Continuous/ Automatic				
Over Load Protection	(Built-in Over Voltage Protection)		150		%
Line Regulation	Single & Dual (H/L to L/L)			±0.5	%
Load Regulation	Single & Dual (F.L-50%F.L)			±0.5	%
Minimum Load	10% of Full Load				
Ripple & Noise	BW=DC To 20MHz (with 1uF Cap.)			150	mVp-p
Transient response setting time	50% Step Load Change			350	us
Capacitive load			2200		uF
External Trim Adj. Range	±10% of Output Voltage				

General Specifications

Parameters	Conditions	Min	Typ	Max	Units
Isolation Resistance	500Vdc	1000			MΩ
Switching Frequency			270		KHz
Operating Temperature		-40		100	°C
Humidity	Non Condensing			95	%
Cooling	Free air Convection				
Case material	Six-Side Shielded Case				
Weight			65		g
Dimensions	Appearance size		50.8X50.8X11.0		mm
Potting Material			Epoxy (UL94V-0 rated)		
Radiated Emissions	EN55022		CLASS A		
Conducted Emissions	EN55022		CLASS A		
Efficiency		79			%
Isolation Voltage	For 10 seconds			3000	VDC
MTBF	MIL-HDBK-217F @25°C , Ground Benign	400000			Hours
Storage Temperature		-50		+100	°C
Case Temperature				+95	°C
Isolation Capacitance				2500	pF



Wide Input Voltage Range 30 Watt Dc-Dc Converter

Temperature Derating Graph

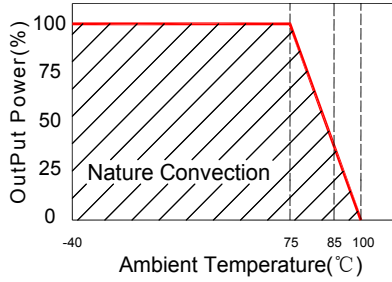

Tolerance Envelope Graph

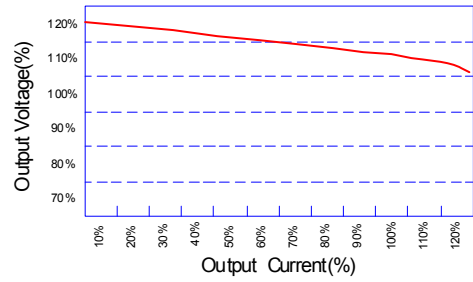

Recommended Test Circuit

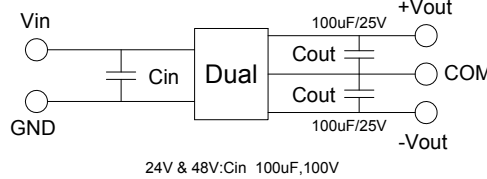
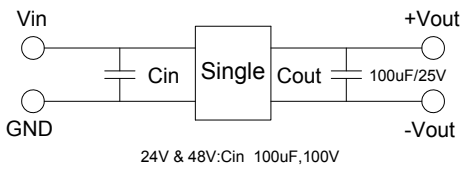

Part Number

96DW - 24 S 03 R NL
 A B C D E F
 A:Series
 B:Input Voltage
 C:Single(S) Dual(D)
 D:Output Voltage
 E:Regulated(R)
 F:RoHS Version

Suggest adding input external filter(C1,C2,C3,L) to meet conducted emissions (EN55022 class A) requirement for the module . These components should be mounted as close as possible to the module; and all leads should be minimized to decrease radiated noise. Exceeding the absolut ratings of the unit could cause damage.It is not allowed for continuous operating

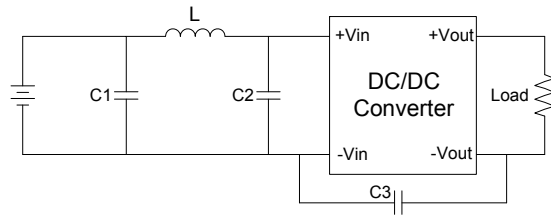

24V: C1 =330uF/100V
 L=12uH
 C3=N/A
 24V: C2 =100uF/100V
 48V: C1 =220uF/100V
 L=12uH
 48V: C2 =100uF/100V
 C3=1000pF/2KV

Markings and dimensions

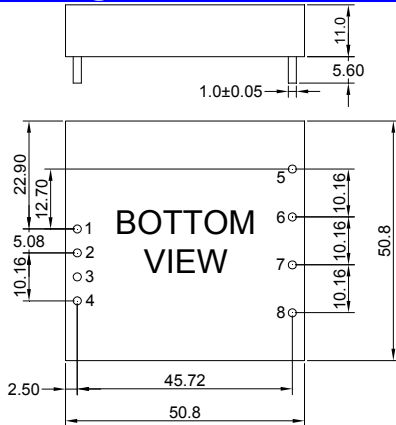

UNIT:mm XX.X±0.5 XX.XX±0.25
 Pin Size Tolerance: 1.0Φ ±0.05mm

Packaging

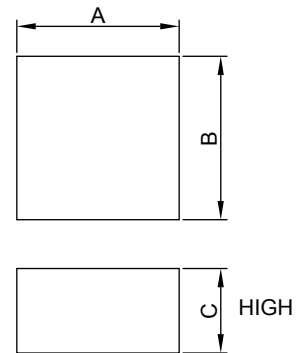

SIZE(mm)		
A	B	C
51.50	52.30	27.00

PIN Connection

PIN	1	2	3	4	5	6	7	8
SINGLE	+Vin	-Vin	NO PIN	Ctrl	NC	+Vout	-Vout	Trim
DUAL	+Vin	-Vin	NO PIN	Ctrl	+Vout	Common	-Vout	Trim