

# 1N4448W

## Silicon Epitaxial Planar Switching Diode

Fast Switching Diode

### PINNING

PIN	DESCRIPTION
1	Cathode
2	Anode

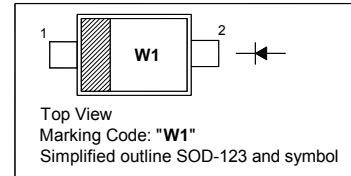

### Absolute Maximum Ratings ( $T_a = 25\text{ }^\circ\text{C}$ )

Parameter	Symbol	Value	Unit
Peak Reverse Voltage	$V_{RM}$	100	V
Reverse Voltage	$V_R$	80	V
Average Rectified Forward Current	$I_{F(AV)}$	150	mA
Forward Continuous Current	$I_{FM}$	300	mA
Non-Repetitive Peak Forward Surge Current (at $t = 1\text{ }\mu\text{s}$ )	$I_{FSM}$	4	A
Power Dissipation	$P_d$	400	mW
Junction Temperature	$T_j$	150	$^\circ\text{C}$
Storage Temperature Range	$T_{stg}$	- 65 to + 150	$^\circ\text{C}$

### Characteristics at $T_a = 25\text{ }^\circ\text{C}$

Parameter	Symbol	Min.	Max.	Unit
Forward Voltage at $I_F = 5\text{ mA}$ at $I_F = 10\text{ mA}$ at $I_F = 100\text{ mA}$ at $I_F = 150\text{ mA}$	$V_F$	0.62 - - -	0.72 0.855 1 1.25	V
Reverse Leakage Current at $V_R = 80\text{ V}$ at $V_R = 20\text{ V}$ at $V_R = 75\text{ V}, T_J = 150\text{ }^\circ\text{C}$ at $V_R = 25\text{ V}, T_J = 150\text{ }^\circ\text{C}$	$I_R$	- - - -	100 25 50 30	nA nA $\mu\text{A}$ $\mu\text{A}$
Reverse Breakdown Voltage at $I_R = 100\text{ }\mu\text{A}$	$V_{(BR)R}$	80	-	V
Total Capacitance at $V_R = 0.5\text{ V}, f = 1\text{ MHz}$	$C_{tot}$	-	4	pF
Reverse Recovery Time at $I_F = I_R = 10\text{ mA}, I_{rr} = 0.1 \times I_R, R_L = 100\text{ }\Omega$	$t_{rr}$	-	4	ns

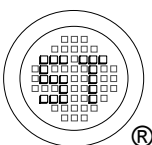

**SEMTECH ELECTRONICS LTD.**  
Subsidiary of Sino-Tech International (BVI) Limited



Dated : 17/03/2010 Rev:01

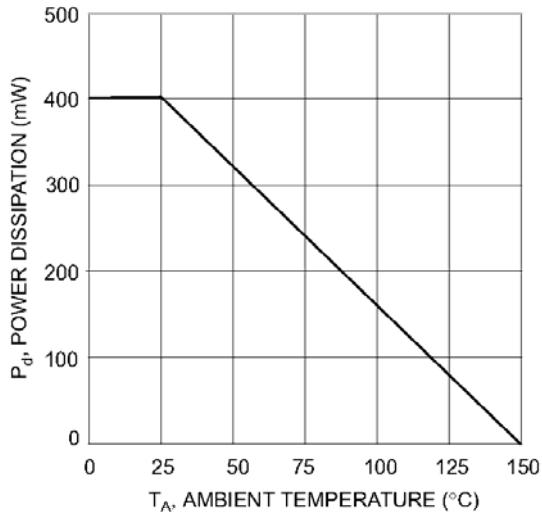

Fig. 1 Power Derating Curve

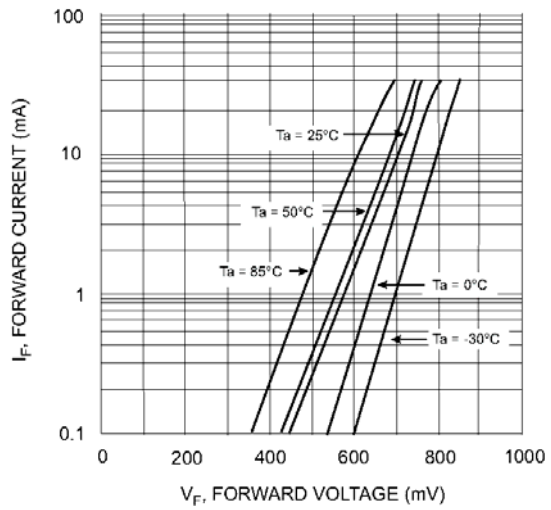

Fig. 2 Typical Forward Characteristics

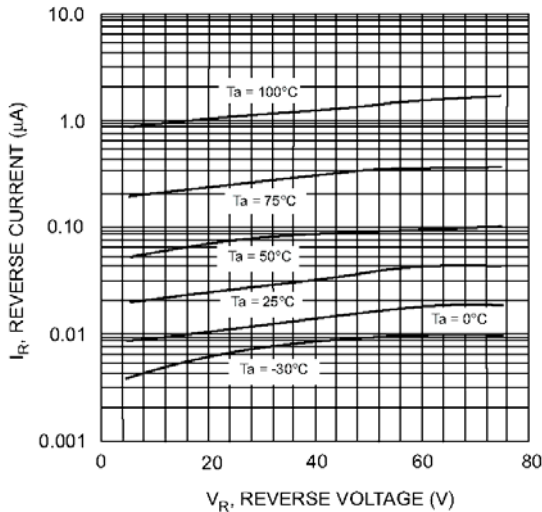

Fig. 3 Typical Reverse Characteristics

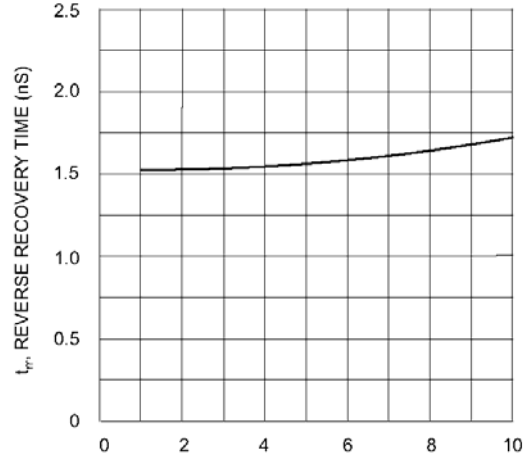

Fig. 4 Reverse Recovery Time vs. Forward Current

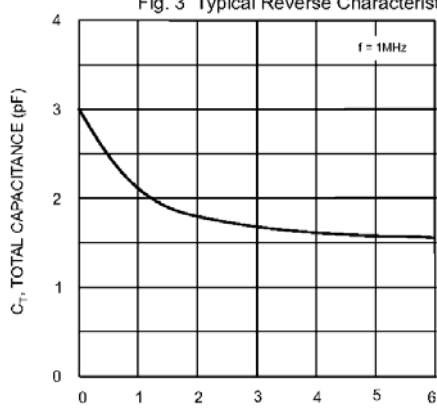
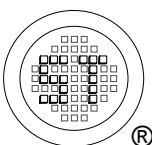

Fig. 5 Total Capacitance vs. Reverse Voltage



**SEMTECH ELECTRONICS LTD.**  
Subsidiary of Sino-Tech International (BVI) Limited



# 1N4448W

## PACKAGE OUTLINE

Plastic surface mounted package; 2 leads

SOD-123

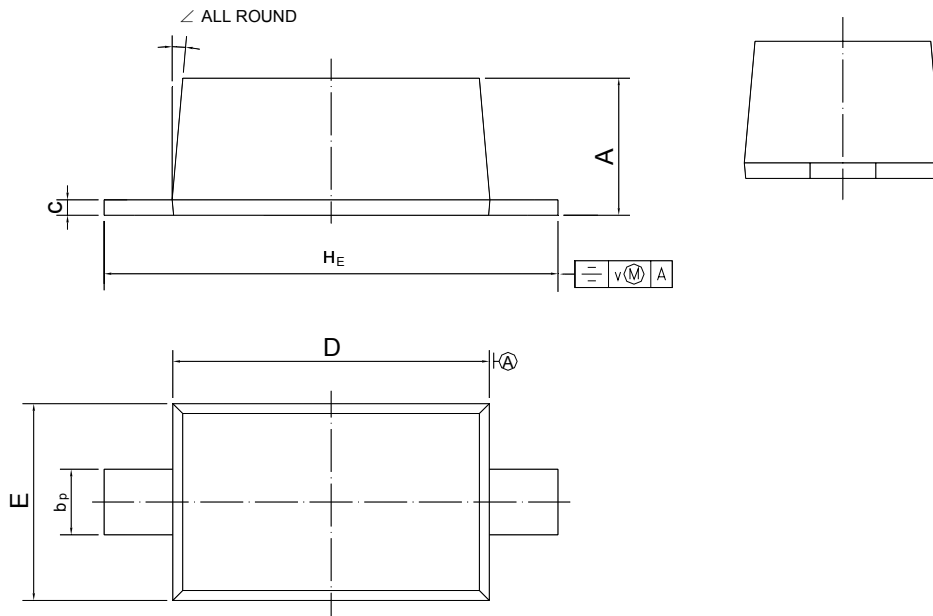

UNIT	A	b <sub>p</sub>	c	D	E	H <sub>E</sub>	v	∠
mm	1.15 1.05	0.6 0.5	0.135 0.100	2.7 2.6	1.65 1.55	3.85 3.55	0.2	5°

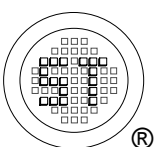

**SEMTECH ELECTRONICS LTD.**  
Subsidiary of Sino-Tech International (BVI) Limited



Dated : 17/03/2010 Rev:01